

DESCRIPTION:

UNIVERSAL LOCKING HAND HOLE COVER (PATENT PENDING) REPLACES EXISTING STOCK COVER AND LOCKS WITH 1"x $\frac{5}{16}$ " KEYED OR COMBO PADLOCK (SUPPLIED BY OTHERS)

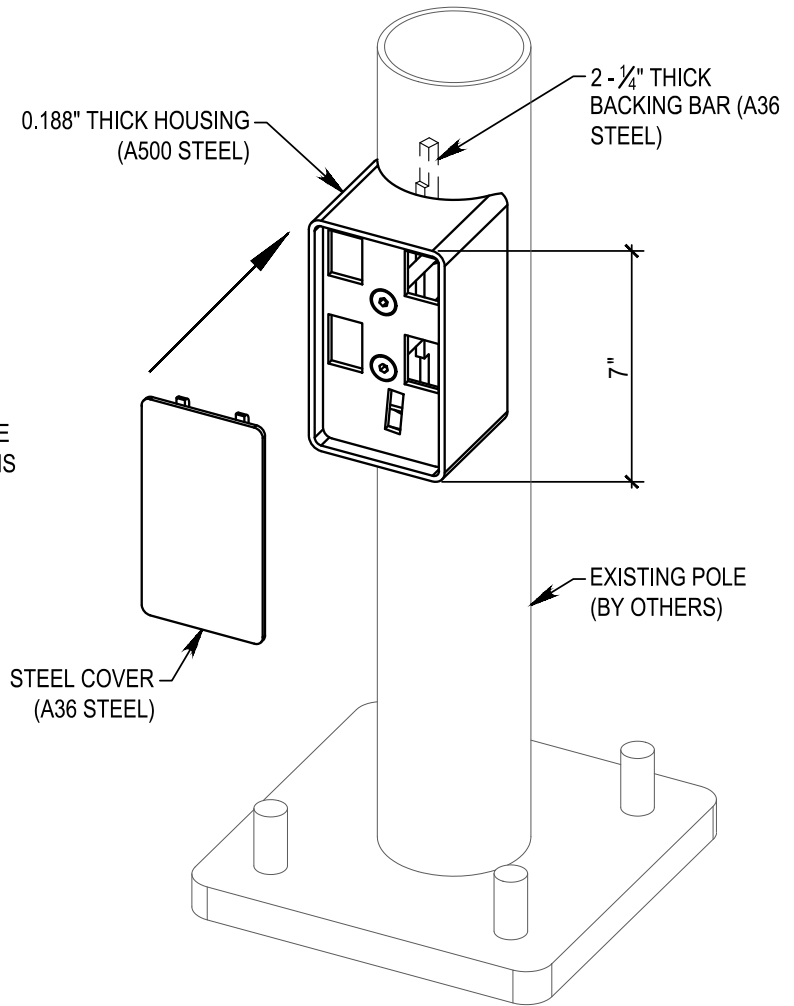
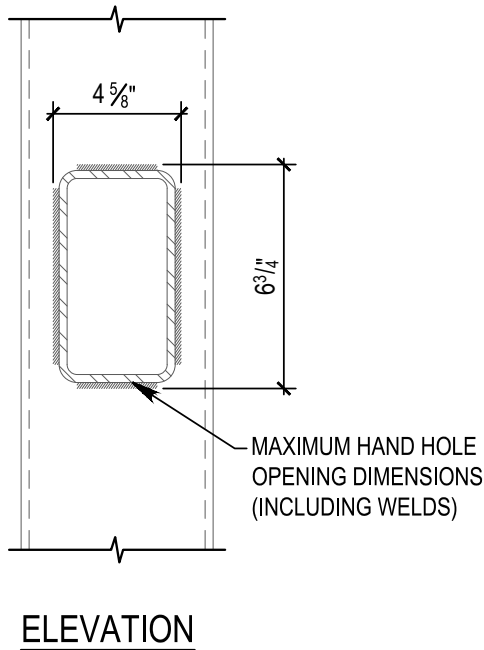
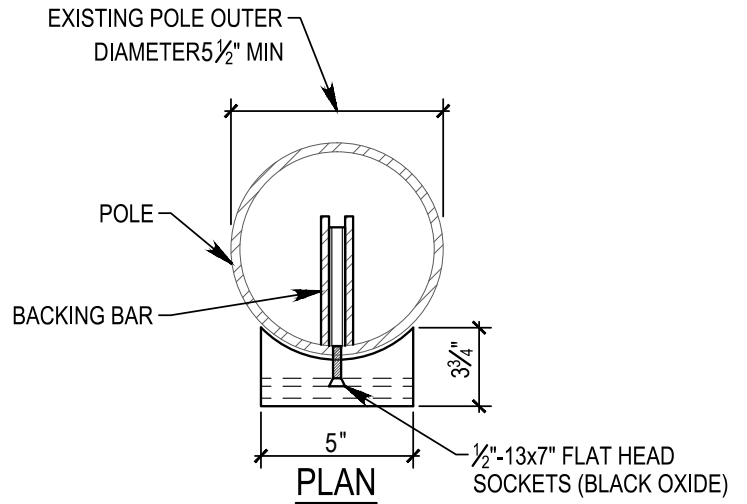

Light Pole Systems, Inc
lightpolesystems.com
 (714) 786-8983
 1057 E. Imerial Hwy #155
 Placentia Ca. 92870

TYPE: UNIVERSAL LOCKING HAND HOLE COVER
 FINISH: COVERS SHIP PRIMED. FINISH AVAILABLE ON SPECIAL ORDER

MODEL#:
5HHCBR5+

5 HHC B R # ← POLE NOMINAL OUTER DIAMETER (INCHES) 5.5+
 ← POLE TYPE (R= ROUND, S=SQUARE)
 ← ATTACHMENT METHOD (B= BOLTED, W= WELDED)
 ← HAND HOLE COVER
 ← COVER WIDTH

SCALE:
NONE

DATE:
5/4/15